

FCC Information and Copyright

This equipment has been tested and found to comply with the limits of a Class B digital device, pursuant to Part 15 of the FCC Rules. These limits are designed to provide reasonable protection against harmful interference in a residential installation. This equipment generates, uses, and can radiate radio frequency energy and, if not installed and used in accordance with the instructions, may cause harmful interference to radio communications. There is no guarantee that interference will not occur in a particular installation.

The vendor makes no representations or warranties with respect to the contents here and specially disclaims any implied warranties of merchantability or fitness for any purpose. Further the vendor reserves the right to revise this publication and to make changes to the contents here without obligation to notify any party beforehand.

Duplication of this publication, in part or in whole, is not allowed without first obtaining the vendor's approval in writing.

The content of this user's manual is subject to be changed without notice and we will not be responsible for any mistakes found in this user's manual. All the brand and product names are trademarks of their respective companies.

Table of Contents

Chapter 1: Introduction	3
1.1 Before You Start	3
1.2 Package Checklist	3
1.3 Mainboard Specification	4
1.4 Rear Panel	5
1.5 Mainboard Layout	6
Chapter 2: Installation	7
2.1 CPU	7
2.2 Fan Header	7
2.3 System Memory	8
2.4 Power Supply	9
2.5 Onboard Slot/Connector/Header/Jumper	10
Chapter 3: BIOS Setup	21
3.1 Main Menu	23
3.2 Advanced Menu	27
3.3 PCI/PnP Menu	37
3.4 Boot Menu	40
3.5 Chipset Menu	43
3.6 Exit Menu	48
Chapter 4: Useful Help	51
4.1 Driver Installation Note	51
4.2 AMI BIOS Beep Code	52
4.3 Troubleshooting	53

CHAPTER 1: INTRODUCTION

1.1 BEFORE YOU START

Thank you for choosing our product. Before you start installing the mainboard, please make sure you follow the instructions below:

- Prepare a dry and stable working environment with sufficient lighting.
- Always disconnect the system from power outlet before operation.
- Before you take the mainboard out from anti-static bag, ground yourself properly by touching any safely grounded appliance, or use grounded wrist strap to remove the static charge.
- Avoid touching the components on mainboard or the rear side of the board unless necessary. Hold the board on the edge, do not try to bend or flex the board.
- Do not leave any unfastened small parts inside the case after installation. Loose parts will cause short circuits which may damage the equipment.
- Keep the system from dangerous area, such as heat source, humid air, and water.
- Please switch on/off the machine normally. That is, DO NOT pull out power cord directly from the mainboard or the system may damage.

1.2 PACKAGE CHECKLIST

- ✚ Mini-ITX Mainboard x 1
- ✚ Fully Setup Driver CD x 1
- ✚ I/O Bracket x 1
- ✚ IDE Cable x 1 (Optional)
- ✚ SATA Cable x 1 (Optional)

1.3 MAINBOARD SPECIFICATION

<i>Specification</i>		
CPU	Intel CPU On-board Intel Atom N270 @1.6GHz (Mobile)	
FSB	Supports up 533 MHz	
Chipset	Northbridge: Intel 945GSE Southbridge: ICH7M	
Graphic	Intel® Graphic Media Accelerator 950	Max Shared Video Memory is 224 MB Supports dual displays (Extended mode) as below: -- 24bit LVDS (by Chrontel CH7308B) -- VGA
Super I/O	ITE IT8718F Provides the most commonly used legacy Super I/O functionality.	128pin type Environment Control initiatives, H/W Monitor Fan Speed Controller
Main Memory	SO-DIMM (200pin) Slot x 1 Supports DDR2 400 / 533 MHz DIMM supports 256MB / 512MB / 1GB / 2GB Max Memory Capacity 2GB	Registered DIMM or ECC DIMM is not supported
IDE	ICH7M	Ultra DMA 33/66/100 Bus Master Mode Supports PIO Mode 0~4 Supports 2 IDE devices
SATA	ICH7M	SATAII Version 1.0a specification compliant Data transfer rates up to 3.0 Gb/s
LAN	Realtek RTL 8111DL x 2	10 / 100 / 1000 Mb/s auto negotiation Half / Full duplex capability
Sound Codec	Realtek ALC662	5.1 channels audio out High-Definition Audio support
Slot	PCI slot x1 Mini PCI-E Slot x1	
On Board Connectors & Headers	IDE Connector x1 SATA2 Connector x2 Front Panel Header x1 Parallel Connector x1 Digital I/O Connector x1 System Fan Header x1 Clear CMOS Header x1	

Specification			
	AT/ATX Power Switch Header	x1	
	USB 2.0 Header	x1	
	LVDS Connector	x1	
	LCD Power Select Header	x1	
	LCD Backlight Power ON/OFF Header	x1	
	LCD Backlight Inverter Connector	x1	
	Inverter Power Select Header	x1	
	Backlight Brightness Adjust Header	x1	
	Serial Connectors		
	COM3 RS-232	x1	
	COM4 RS-232	x1	
	COM5 RS-232	x1	
	COM6 RS-232	x1	
	Power Connector (20pin)	x1	
Back Panel I/O	PS/2 Keyboard	x1	1 x RS-232, 1 x RS-232/422/485 by jumper
	PS/2 Mouse	x1	
	Serial Port	x2	
	VGA Port	x1	
	LAN port	x2	
	USB Port	x4	
	Audio Jack	x3	
Board Size	170 mm (W) x 170 mm (L)		Mini-ITX
OS Support	Windows XP/XPE, Linux		Biostar reserves the right to add or remove support for any OS with or without notice.

1.4 REAR PANEL

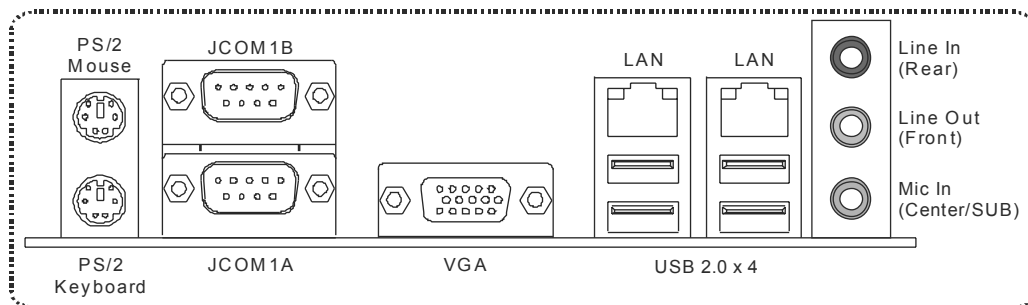

1.5 MAINBOARD LAYOUT

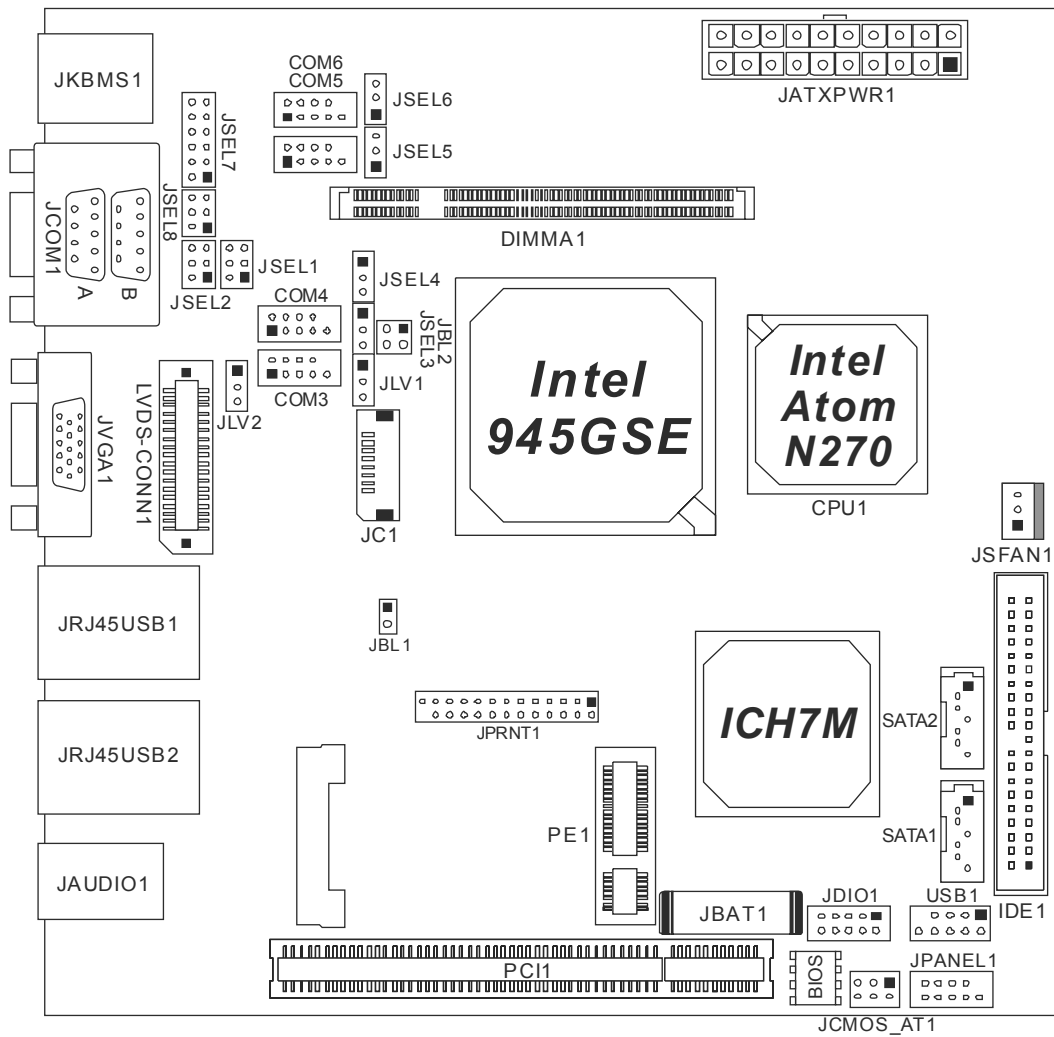

Note: ■ represents the 1st pin.

CHAPTER 2: INSTALLATION

2.1 CPU

The mainboard includes an embedded Intel Atom N270 processor, and a heatsink has been installed to provide sufficient cooling.

2.2 FAN HEADER

The fan header supports cooling-fans built in the system. The fan cable and connector may be different due to the fan manufacturer.

JSFAN1: System Fan Header

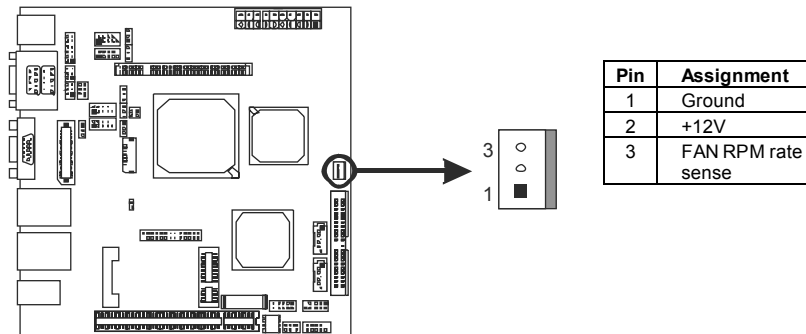

Note:

The System Fan Header supports 3-pin head connector. When connecting with wires onto connectors, please note that the red wire is the positive and should be connected to pin#2, and the black wire is Ground and should be connected to GND.

2.3 SYSTEM MEMORY

DIMMA1: Memory Module (200pin SO-DIMM)

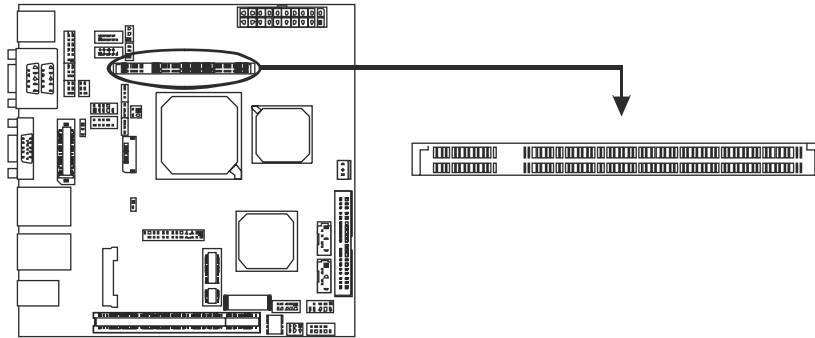

- 2 Align a DIMM on the slot such that the notch on the DIMM matches the break on the Slot.
- 3 Insert the DIMM firmly into the slot until the retaining chip snap back in place and the DIMM is properly seated.

Memory Capacity

DIMM Socket Location	DDR2 Module	Total Memory Size
DIMMA1	256MB/512MB/1GB/2GB	Max is 2GB.

2.4 POWER SUPPLY

JATXPWR1: ATX Power Source Connector (20-pin)

This connector allows user to connect 20-pin power connector on the power supply.

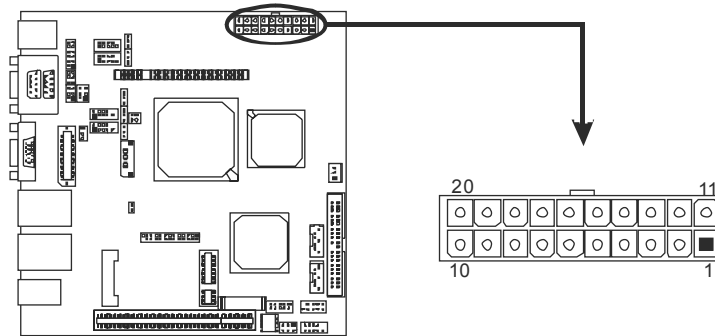

Pin	Assignment	Pin	Assignment
1	+3.3V	11	+3.3V
2	+3.3V	12	-12V
3	GND	13	GND
4	+5V	14	Power Supply On
5	GND	15	GND
6	+5V	16	GND
7	GND	17	GND
8	Power Good	18	NC
9	+5V Standby	19	+5V
10	+12V	20	+5V

2.5 ONBOARD SLOT/CONNECTOR/HEADER/JUMPER

PCI1: Peripheral Component Interconnect Slot

This mainboard is equipped with 1 standard PCI slot. PCI stands for Peripheral Component Interconnect, and it is a bus standard for expansion cards. This PCI slot is designated as 32 bits.

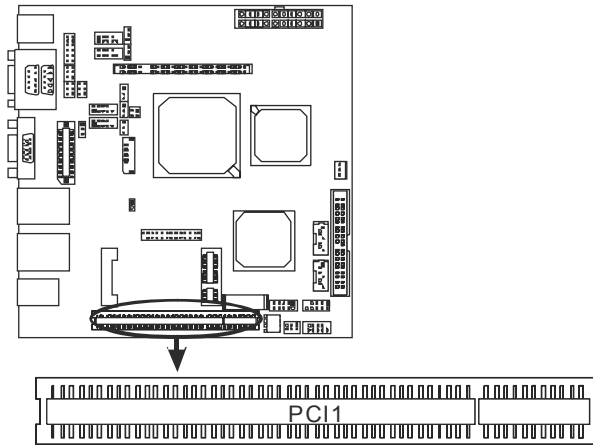

PE1: Mini PCI-E Slot

This mainboard is equipped with 1 Mini PCI-E Slot.

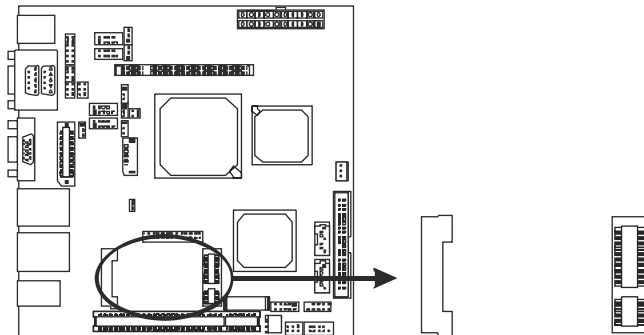

IDE1: ATA Device Connector

The mainboard has an integrated IDE Controller that provides PIO Mode 0~4, Bus Master, and Ultra DMA 33/66/100 functionality. It has one IDE connector which can connect a master and a slave drive, so you can connect up to two ATA devices.

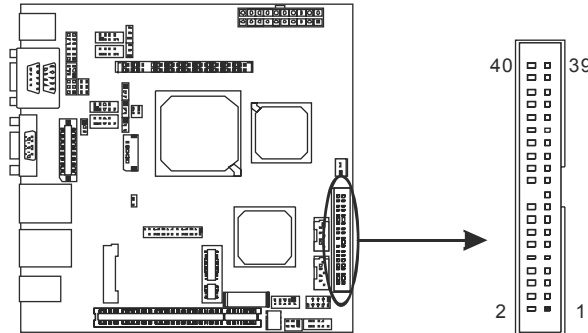

SATA1/SATA2: Serial ATA Connectors

These next generation connectors support the thin Serial ATA cable for primary internal storage devices. The current Serial ATA interface allows up to 3.0 Gbit/s data transfer rate.

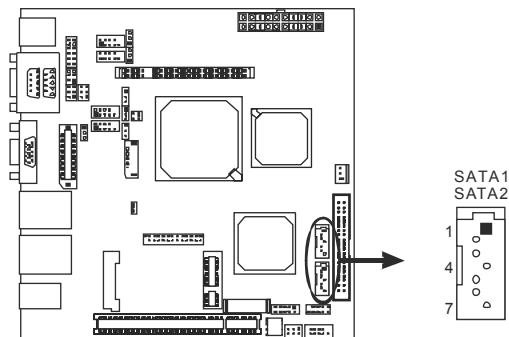

Pin	Assignment
1	GND
2	TX+
3	TX-
4	GND
5	RX-
6	RX+
7	GND

Mini-ITX Mainboard Manual

JPANEL1: Front Panel Header

This 10-pin header includes Power-on, Reset, HDD LED, and Power LED connection. It allows user to connect the system case's front panel switch functions.

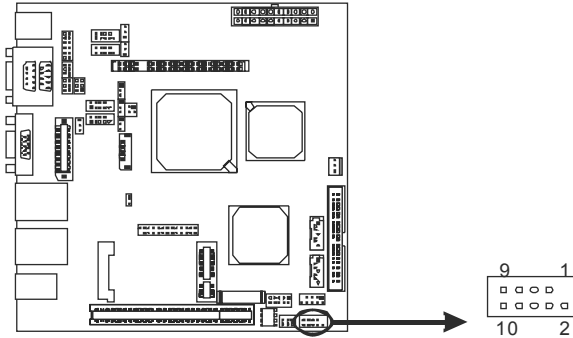

Pin	Assignment	Function	Pin	Assignment	Function
1	Key	N/A	2	Power LED+	Power LED
3	HD LED+	HDD LED	4	Power LED+	
5	HD LED-		6	Power LED-	
7	Reset GND	Reset Button	8	Power	Power Button
9	Reset		10	Power GND	

USB1: USB 2.0 Header

The mainboard provides 1 front USB pin header, allowing up to 2 additional USB 2.0 ports up to maximum throughput of 480 Mbps. Connect the USB cable into the pin header for using high-speed USB interface peripherals.

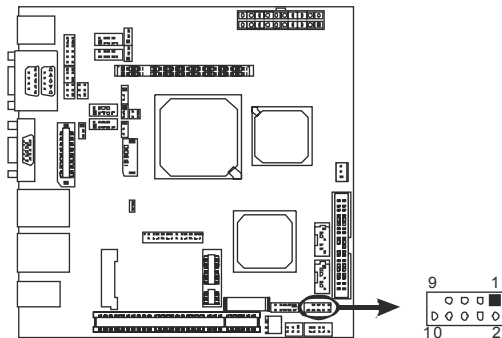

Pin	Assignment	Pin	Assignment
1	+5V (fused)	2	+5V (fused)
3	USB6-	4	USB7-
5	USB6+	6	USB7+
7	Ground	8	Ground
9	Key	10	NC

JCOM1A /JCOM1B : Serial port Connectors

The motherboard has Serial Port Connectors for connecting RS-232 Port. Only JCOM1A supports RS-422/485.

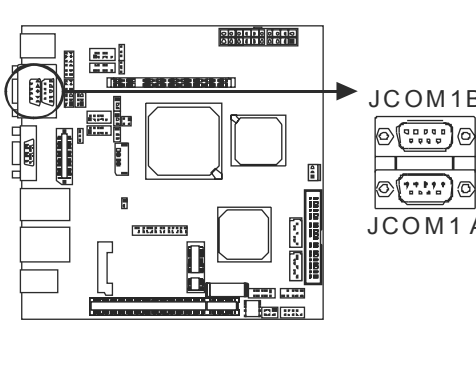

	RS-232	RS-422	RS-485
Pin	Assignment		
1	Carrier detect (DCD)	TX-	TX-
2	Received data (RXD)	TX	TX
3	Transmitted data (TXD)	RX	NC
4	Data terminal ready (DTR)	RX-	NC
5	Signal ground (GND)	GND	GND
6	Data set ready (DSR)	NC	NC
7	Request to send (RTS)	NC	NC
8	Clear to send (CTS)	NC	NC
9	Ring	NC	NC

JSEL1/JSEL2: Ring/5V/12V Switch Header for JCOM1A/JCOM1B

JSEL1 and JSEL2 respectively control Pin 9 of JCOM1A/JCOM1B for Ring/5V/12V.

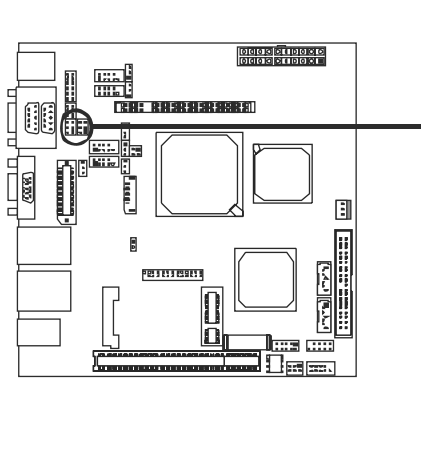

JSEL2 JSEL1



Pin 1-2 Close:
Ring (Default)



Pin 3-4 Close:
5V



Pin 5-6 Close:
12V

JSEL7/JSEL8: RS-232/422/485 Switch Headers

The headers determine that JCOM1A belongs to RS-232 (Default), 422, or 485.

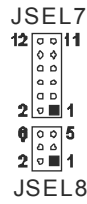
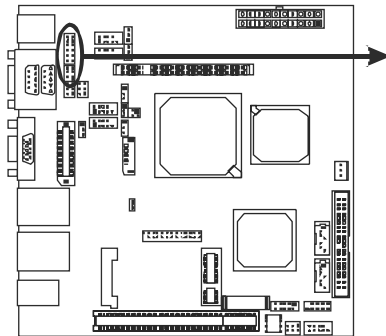

JSEL7		
RS-232	RS-422	RS-485
1-3	3-5	3-5
2-4	4-6	4-6
7-9	9-11	9-11
8-10	10-12	10-12
JSEL8		
1-2	RS-232	
3-4	RS-422	
5-6	RS-485	

COM3 ~ COM6: Serial Port Connectors

The motherboard has 4 Serial Port Connectors for connecting RS-232 Port.

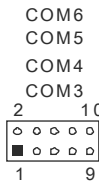
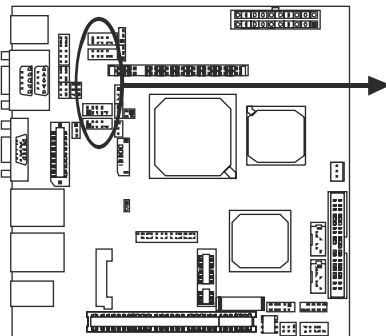

Pin	Assignment
1	-PDCD
2	PSIN
3	PSOUT data
4	-PDTR
5	GND
6	-PDSR
7	-PRTS
8	-PCTS
9	-PRI
10	5V / 12V

JSEL3 ~ JSEL6: 5V/12V Switch Header for COM3 ~ COM6

JSEL3 ~ JSEL6 respectively control Pin 10 of COM3 ~ COM6 for 5V/12V.

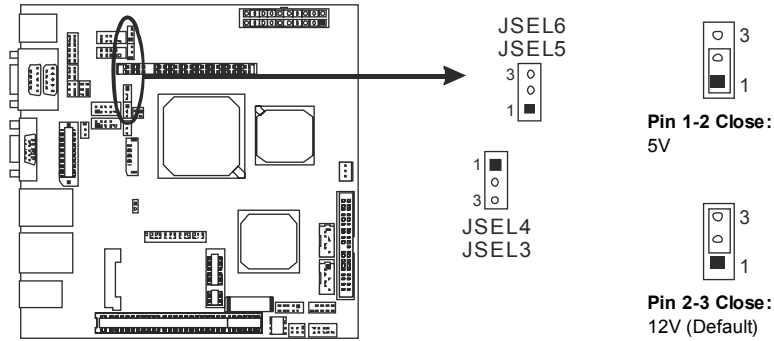

JDIO1: Digital I/O Connector

This connector offers 4-pair of digital I/O functions and address is set in BIOS. The default address is: A21H: Output bit0~3; A22H: Input bit0~3.

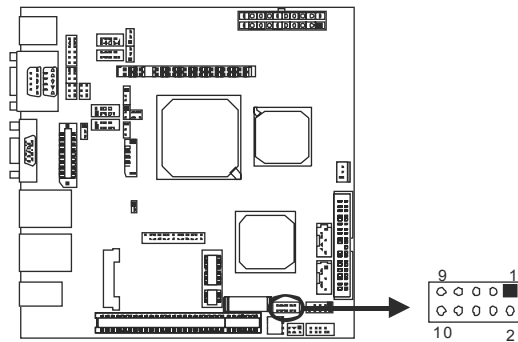

Pin	Assignment
1	5V
2	Digital-In-30
3	Digital-Out-20
4	Digital-In-31
5	Digital-Out-21
6	Digital-In-32
7	Digital-Out-22
8	Digital-In-33
9	Digital-Out-23
10	GND

JCMOS_AT1: Clear CMOS Header *

Placing the jumper on pin1, 3, 5 allows user to restore the BIOS safe setting and the CMOS data. Please carefully follow the procedures to avoid damaging the mainboard.

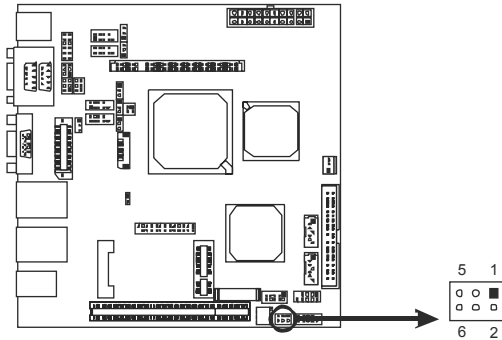

Pin 1-3 Close: (Default)
Normal Operation.



Pin 3-5 Close:
Clear CMOS data.

※ Clear CMOS Procedures:

1. Remove AC power line.
2. Set the jumper to “Pin 3-5 close”.
3. Wait for five seconds.
4. Set the jumper to “Pin 1-3 close”.
5. Power on the AC.
6. Reset your desired password or clear the CMOS data.

JCMOS_AT1: AT/ATX Power Switch Header *

The header of pin2, 4, 6 is for switching between AT and ATX power.

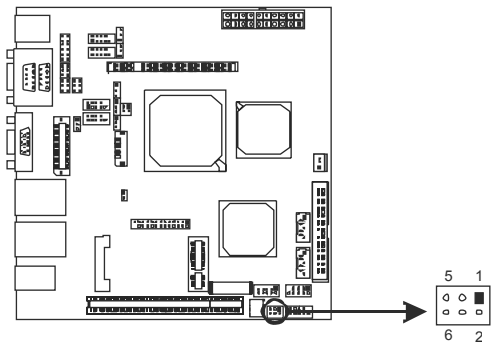

Pin 2-4 Close:
For AT Power



Pin 4-6 Close: (Default)
For ATX Power

JPRNT1: Printer Port Connector

This header allows you to connect printer port on the PC.

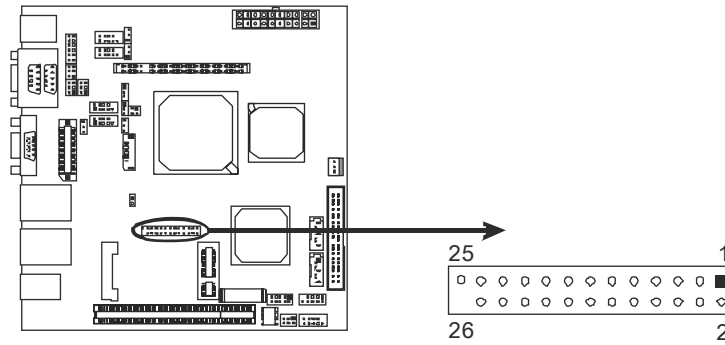

Pin	Assignment	Pin	Assignment
1	-Strobe	14	Ground
2	-ALF	15	Data 6
3	Data 0	16	Ground
4	-Error	17	Data 7
5	Data 1	18	Ground
6	-Init	19	-ACK
7	Data 2	20	Ground
8	-Scitn	21	Busy
9	Data 3	22	Ground
10	Ground	23	PE
11	Data 4	24	Ground
12	Ground	25	SCLT
13	Data 5	26	Key

LVDS-CONN1: LVDS Connector

This connector is for devices requiring display interface such as LVDS.

This connector supports 18/24-bit dual-channel panels up to UXGA (1600 x 1200)

- It is strongly recommended to use the matching JOY DAY INDUSTRIAL - A1252WV-SF-2X20PD01 connector.

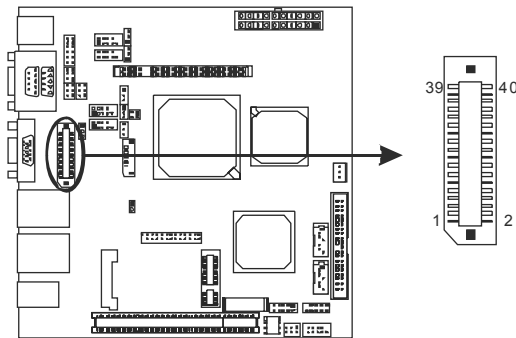

Pin	Assignment	Pin	Assignment
1	LVDS2_TX0- (Differential signal)	2	PVDD (+3.3V or +5V)
3	LVDS2_TX0+ (Differential signal)	4	PVDD (+3.3V or +5V)
5	GND	6	GND
7	LVDS2_TX1- (Differential signal)	8	GND
9	LVDS2_TX1+ (Differential signal)	10	LVDS1_TX0- (Differential signal)
11	GND	12	LVDS1_TX0+ (Differential signal)
13	LVDS2_TX2- (Differential signal)	14	GND
15	LVDS2_TX2+ (Differential signal)	16	LVDS1_TX1- (Differential signal)
17	GND	18	LVDS1_TX1+ (Differential signal)
19	LVDS2_CLK- (Differential signal)	20	GND
21	LVDS2_CLK+ (Differential signal)	22	LVDS1_TX2- (Differential signal)
23	GND	24	LVDS1_TX2+(Differential signal)
25	LVDS2_TX3-	26	GND
27	LVDS2_TX3+	28	LVDS1_CLK- (Differential signal)
29	+5V	30	LVDS1_CLK+(Differential signal)
31	I2C_CLK	32	GND
33	+3.3V	34	LVDS1_TX3-
35	NC	36	LVDS1_TX3+
37	PVDD (+3.3V or +5V)	38	NC
39	PVDD (+3.3V or +5V)	40	I2C_DATA

JLV2: LCD Power Select Header *

This header allows you to select LCD Power.

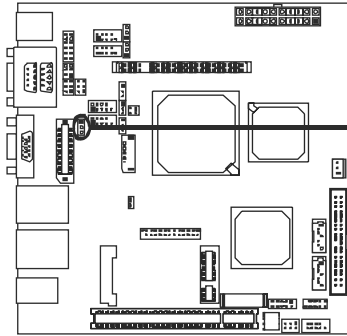

Pin 1-2 Close:
PVDD=3.3V (Default)



Pin 2-3 Close:
PVDD=5V

JLV1: LCD Backlight Inverter Power Select Header *

This header is for selecting LCD Backlight Inverter Power.

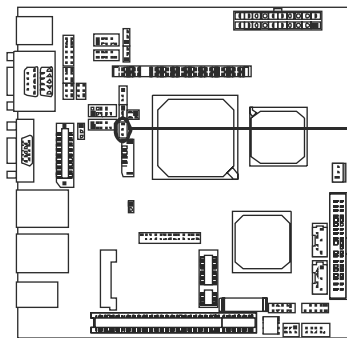

Pin 1-2 Close:
Inverter Power=5V
(Default)



Pin 2-3 Close:
Inverter Power=12V

JBL1: LCD Backlight Power ON/OFF Header *

This header allows you to control the LCD Backlight Power ON/OFF.

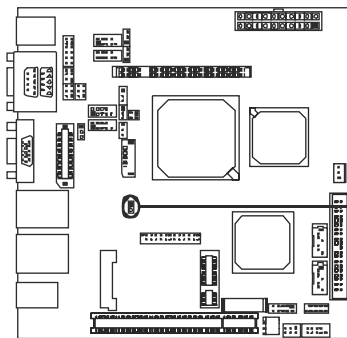

Header Close:
Backlight Power OFF



Header Open:
Backlight Power ON

JBL2: LCD Backlight Brightness Adjust Header *

This header is for adjusting LCD backlight brightness.

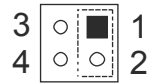
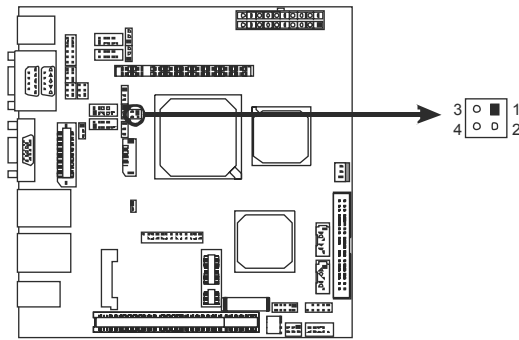

Short Pin 1-2:
Increase Brightness

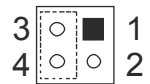

Short Pin 3-4:
Decrease Brightness

JC1: LCD Backlight Inverter Connector

This connector is for connecting to LCD for providing backlight control function. It is strongly recommended to use the matching JOY DAY INDUSTRIAL – A1250WV-S-8P connector.

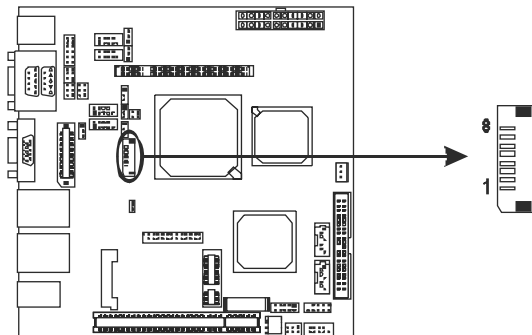

Pin	Assignment
1	5V/12V DC
2	5V/12V DC
3	NC
4	NC
5	Backlight On
6	Brightness Adjust
7	GND
8	GND

***How to Setup Jumpers**

The illustration shows how to set up jumpers. When the jumper cap is placed on pins, the jumper is “close”, if not, that means the jumper is “open”.



Pin opened



Pin closed



Pin1-2 closed

CHAPTER 3: BIOS SETUP

Introduction

The purpose of this chapter is to describe the settings in the AMI BIOS Setup program on this motherboard. The Setup program allows users to modify the basic system configuration and save these settings to CMOS RAM. The power of CMOS RAM is supplied by a battery so that it retains the Setup information when the power is turned off.

Basic Input-Output System (BIOS) determines what a computer can do without accessing programs from a disk. This system controls most of the input and output devices such as keyboard, mouse, serial ports and disk drives. BIOS activates at the first stage of the booting process, loading and executing the operating system. Some additional features, such as virus and password protection or chipset fine-tuning options are also included in BIOS.

The rest of this manual will to guide you through the options and settings in BIOS Setup.

Plug and Play Support

This AMI BIOS supports the Plug and Play Version 1.0A specification.

EPA Green PC Support

This AMI BIOS supports Version 1.03 of the EPA Green PC specification.

ACPI Support

AMI ACPI BIOS support Version 1.0/2.0 of Advanced Configuration and Power interface specification (ACPI). It provides ASL code for power management and device configuration capabilities as defined in the ACPI specification, developed by Microsoft, Intel and Toshiba.

PCI Bus Support

This AMI BIOS also supports Version 2.3 of the Intel PCI (Peripheral Component Interconnect) local bus specification.

DRAM Support

DDR2 SDRAM (Double Data Rate II Synchronous DRAM) is supported.

Supported CPUs

This AMI BIOS supports the Intel CPU.

Using Setup

When starting up the computer, press during the **Power-On Self-Test (POST)** to enter the BIOS setup utility.

In the BIOS setup utility, you will see **General Help** description at the top right corner, and this is providing a brief description of the selected item. **Navigation Keys** for that particular menu are at the bottom right corner, and you can use these keys to select item and change the settings.

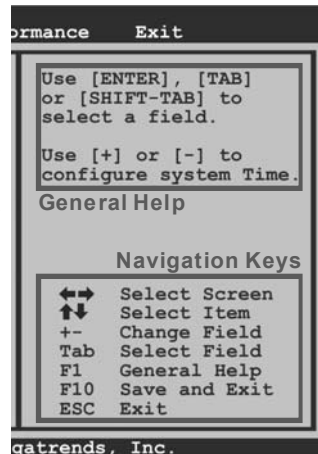

Notice

- The default BIOS settings apply for most conditions to ensure optimum performance of the motherboard. If the system becomes unstable after changing any settings, please load the default settings to ensure system's compatibility and stability. Use Load Setup Default under the Exit Menu.
- For better system performance, the BIOS firmware is being continuously updated. The BIOS information described in this manual is for your reference only. The actual BIOS information and settings on board may be slightly different from this manual.
- The content of this manual is subject to be changed without notice. We will not be responsible for any mistakes found in this user's manual and any system damage that may be caused by wrong-settings.

3.1 MAIN MENU

Once you enter AMI BIOS Setup Utility, the Main Menu will appear on the screen providing an overview of the basic system information.



AMI BIOS

Shows system information including BIOS version, built date, etc.

System Memory

Shows system memory size, VGA shard memory will be excluded..

System Time

Set the system internal clock.

System Date

Set the system date. Note that the 'Day' automatically changes when you set the date.

IDE Configuration

The BIOS will automatically detect the presence of IDE/SATA devices. There is a sub-menu for each IDE/SATA device. Select a device and press <Enter> to enter the sub-menu of detailed options.

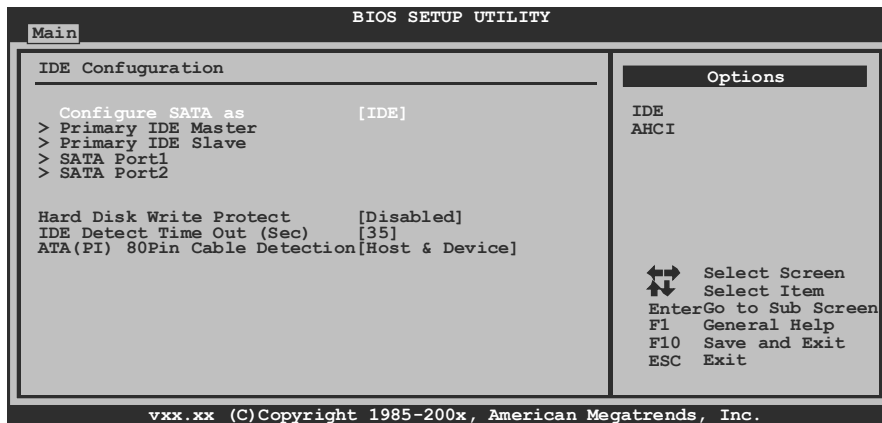

Configure SATA as

This item allows you to determine the control mode of SATA.

Options: IDE (Default) / AHCI

Primary IDE Master/Slave & SATA Port1/2 Devices

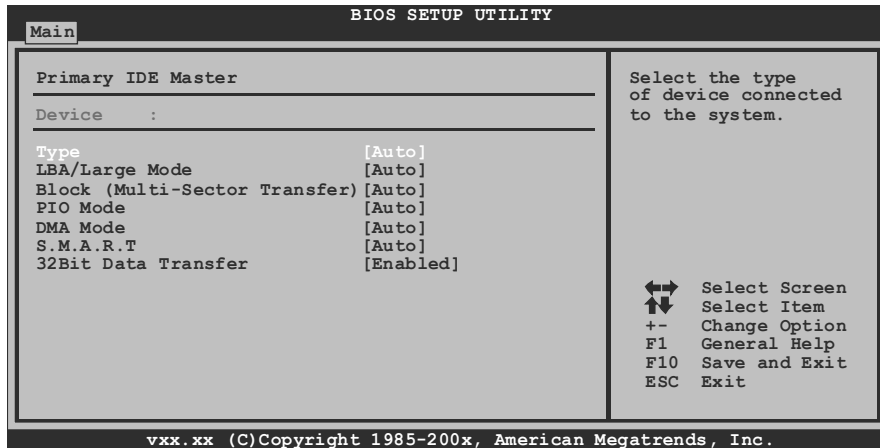

The BIOS detects the information and values of respective devices, and these information and values are shown below to the name of the sub-menu.

Type

Select the type of the SATA drive.

Options: Auto (Default) / CD/DVD / ARMD / Not Installed

LBA/Large Mode

Enable or disable the LBA mode.

Options: Auto (Default) / Disabled

Block (Multi-Sector Transfer)

Enable or disable multi-sector transfer.

Options: Auto (Default) / Disabled

PIO Mode

Select the PIO mode.

Options: Auto (Default) / 0 / 1 / 2 / 3 / 4

DMA Mode

Select the DMA mode.

Options: Auto (Default) / SWDMA0 ~ SWDMA2 / MWDMA0 ~ MWDMA2 /
UDMA0 ~ UDMA5

Mini-ITX Mainboard Manual

S.M.A.R.T

Set the Smart Monitoring, Analysis, and Reporting Technology.

Options: Auto (Default) / Disabled / Enabled

32Bit Data Transfer

Enable or disable 32-bit data transfer.

Options: Enabled (Default) / Disabled

Hard Disk Write Protect

Disable or enable device write protection. This will be effective only if the device is accessed through BIOS.

Options: Disabled (Default) / Enabled

IDE Detect Time Out (Sec)

Select the time out value for detecting IDE/SATA devices.

Options: 35 (Default) / 30 / 25 / 20 / 15 / 10 / 5 / 0

ATA(PI) 80Pin Cable Detection

Select the mechanism for detecting 80Pin ATA(PI) Cable.

Options: Host & Device (Default) / Host / Device

3.2 ADVANCED MENU

The Advanced Menu allows you to configure the settings of CPU, Super I/O, Power Management, and other system devices.

Notice

- Beware of that setting inappropriate values in items of this menu may cause system to malfunction.

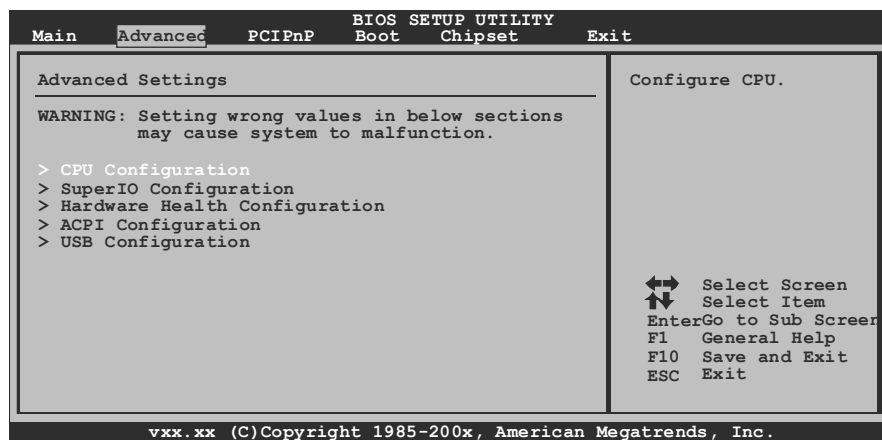

CPU Configuration

This item shows the CPU information that the BIOS automatically detects.

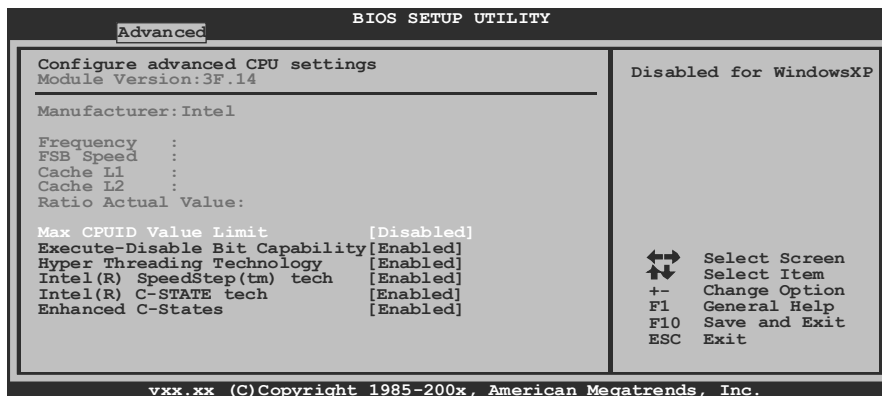

Max CPUID Value Limit

When the computer is booted up, the operating system executes the CPUID instruction to identify the processor and its capabilities. Before it can do so, it must first query the processor to find out the highest input value CPUID recognizes. This determines the kind of basic information CPUID can provide the operating system.

Options: Disabled (Default) / Enabled

Execute-Disable Bit Capability

This item allows you to configure the Execute Disabled Bit function, which protects your system from buffer overflow attacks.

Options: Enabled (Default) / Disabled

Hyper Threading Technology

Enabled for Windows XP and Linux (OS optimized for Hyper Threading Technology) and disabled for other OS (OS not optimized for Hyper Threading Technology).

Options: Enabled (Default) / Disabled

Intel(R) SpeedStep(tm) Tech

This item allows you to enable SpeedStep technology for better power saving. SpeedStep is a technology built into some Intel processors that allows the clock speed of the processor to be dynamically changed by software.

Options: Enabled (Default) / Disabled

Intel(R) C-STATE Tech

This item allows you to control the C-State power management functions of the processor.

Options: Enabled (Default) / Disabled

Enhanced C-States

This item allows you to control the enhanced C-States feature.

Option: Enabled (Default) / Disabled

SuperIO Configuration

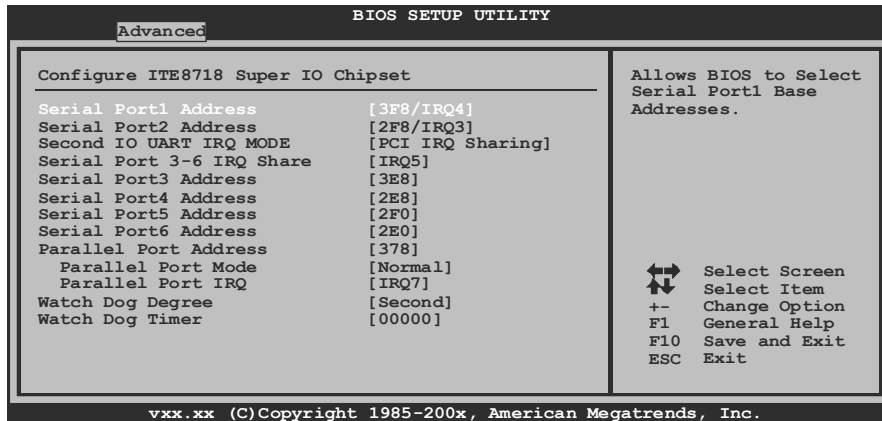

Serial Port1 Address

Select an address and corresponding interrupt for Serial Port 1.
Options: 3F8/IRQ4 (Default) / 3E8/IRQ4 / 2E8/IRQ3 / Disabled

Serial Port2 Address

Select an address and corresponding interrupt for Serial Port 2.
Options: 2F8/IRQ3 (Default) / 3E8/IRQ4 / 2E8/IRQ3 / Disabled

Second IO UART IRQ MODE

PCI IRQ Sharing for OS (EX. WinXP); ISA IRQ Sharing for Dos.
Options: PCI IRQ Sharing (Default) / ISA IRQ

Serial Port 3-6 IRQ Share

This item allows you to determine whether Serial Port 3-6 share IRQ.
Options: IRQ5 (Default) / Disabled / IRQ3 / IRQ4 / IRQ7 / IRQ9 / IRQ10 / IRQ11

Serial Port3 Address

This item allows you to select the address of Serial Port3.
Options: 3E8 (Default) / 2E8 / 2F0 / 2E0

Serial Port3 IRQ

This item allows you to select IRQ of Serial Port3.

Options: IRQ5 (Default) / IRQ3 / IRQ4 / IRQ7 / IRQ9 / IRQ10 / IRQ11

Serial Port4 Address

This item allows you to select the address of Serial Port4.

Options: 2E8 (Default) / 3E8 / 2F0 / 2E0

Serial Port4 IRQ

This item allows you to select IRQ of Serial Port4.

Options: IRQ5 (Default) / IRQ3 / IRQ4 / IRQ7 / IRQ9 / IRQ10 / IRQ11

Serial Port5 Address

This item allows you to select the address of Serial Port5.

Options: 2F0 (Default) / 3E8 / 2E8 / 2E0

Serial Port5 IRQ

This item allows you to select IRQ of Serial Port5.

Options: IRQ5 (Default) / IRQ3 / IRQ4 / IRQ7 / IRQ9 / IRQ10 / IRQ11

Serial Port6 Address

This item allows you to select the address of Serial Port6.

Options: 2E0 (Default) / 3E8 / 2E8 / 2F0

Serial Port6 IRQ

This item allows you to select IRQ of Serial Port6.

Options: IRQ5 (Default) / IRQ3 / IRQ4 / IRQ7 / IRQ9 / IRQ10 / IRQ11

Parallel Port Address

This item allows you to determine access onboard parallel port controller with which I/O Address.

Options: 378 (Default) / 278 / 3BC / Disabled

Parallel Port Mode

This item allows you to determine how the parallel port should function.

Options: Normal (Default)	Using Parallel port as Standard Printer Port.
EPP	Using Parallel Port as Enhanced Parallel Port.
ECP	Using Parallel port as Extended Capabilities Port.
ECP+EPP	Using Parallel port as ECP & EPP mode.

ECP Mode DMA Channel

This item allows you to select parallel port ECP DMA.

Options: DMA3 (Default) / DMA0 / DMA1

Parallel Port IRQ

This item allows you to select the IRQ for the onboard parallel port.

Options: IRQ7 (Default) / IRQ5

Watch Dog Degree

This item allows you to determine the functional degree of Watch Dog.

Options: Second (Default) / Minute

Watch Dog Timer

Options: 0 for disabled (Default) / Min=1, Max=65536

Hardware Health Configuration

This item shows the system temperature, fan speed, and voltage information.

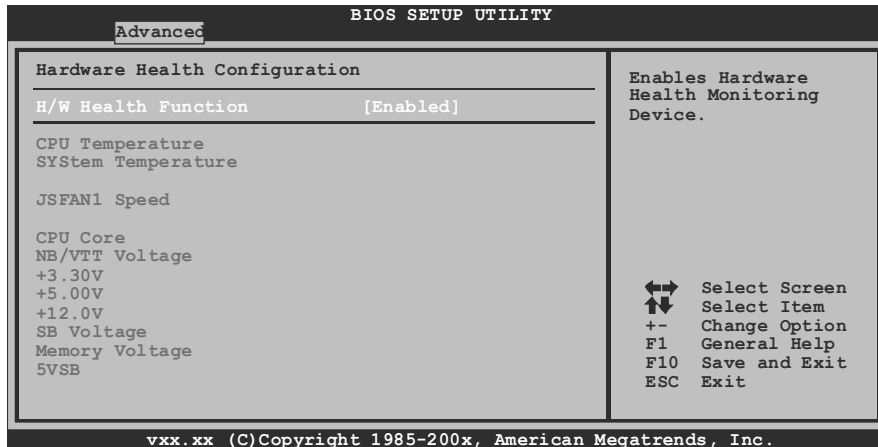

H/W Health Function

If with a monitoring system, PC will show PC health status during POST stage.
Options: Enabled (Default) / Disabled

ACPI Configuration

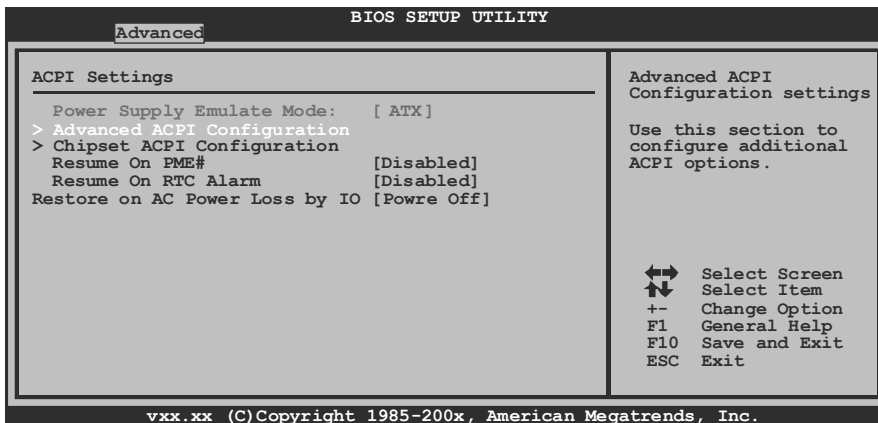

Advanced ACPI Configuration

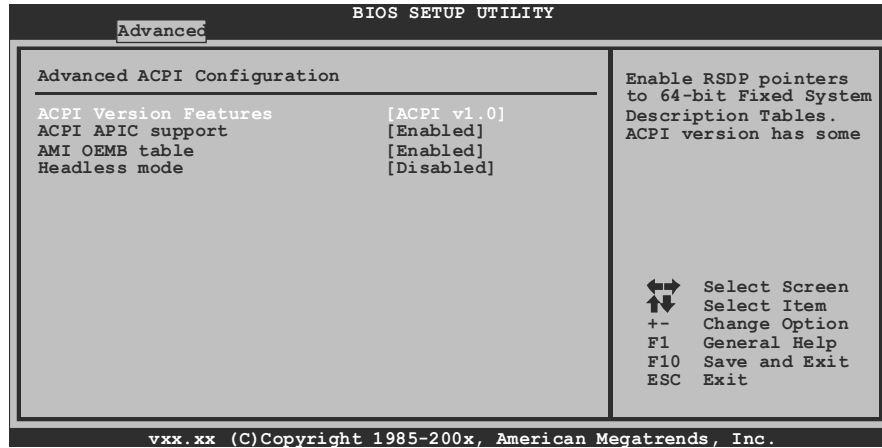

ACPI Version Features

The item allows you to select the version of ACPI.

Options: ACPI v1.0 (Default) / ACPI v2.0 / ACPI v3.0

ACPI APIC support

This item is used to enable or disable the motherboard's APIC (Advanced Programmable Interrupt Controller). The APIC provides multiprocessor support, more IRQs and faster interrupt handling.

Options: Enabled (Default) / Disabled

AMI OEMB table

Set this value to allow the ACPI BIOS to add a pointer to an OEMB table in the Root System Description Table (RSDT) table.

Options: Enabled (Default) / Disabled

Headless mode

This is a server-specific feature. A headless server is one that operates without a keyboard, monitor or mouse. To run in headless mode, both BIOS and operating system (e.g. Windows Server 2003) must support headless operation.

Options: Disabled (Default) / Enabled

Chipset ACPI Configuration

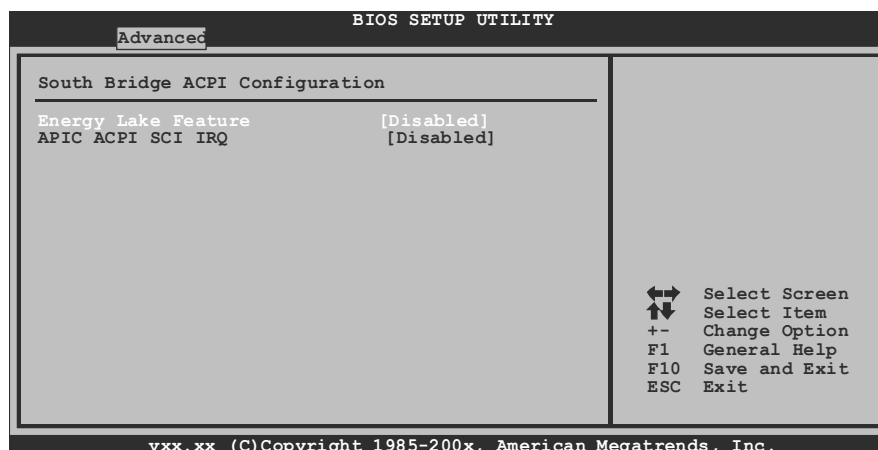

Energy Lake Feature

This item allows you to enable or disable the Energy Lake technology feature.
Options: Disabled (Default) / Enabled

APIC ACPI SCI IRQ support

This item is used to set APIC ACPI SCI by IRQ.
Options: Disabled (Default) / Enabled

Resume On PME#

This item allows you to disable or enable PME to generate a wake event.
Options: Disabled (Default) / Enabled

Resume On RTC Alarm

When “Enabled”, you can set the date and time at which the RTC (real-time clock) alarm awakens the system from Suspend mode.
Options: Disabled (Default) / Enabled

RTC Alarm Date (Days)

You can choose which date the system will boot up.

RTC Alarm Time

You can choose the system boot up time, input hour, minute and second to specify.

Restore on AC Power Loss by IO

This setting specifies how your system should behave after a power fail or interrupts occurs. By choosing Disabled will leave the computer in the power off state. Choosing Enabled will restore the system to the status before power failure or interrupt occurs.

Options: Power Off (Default) / Power ON / Last State

USB Configuration

This item shows the USB controller and using USB device information.

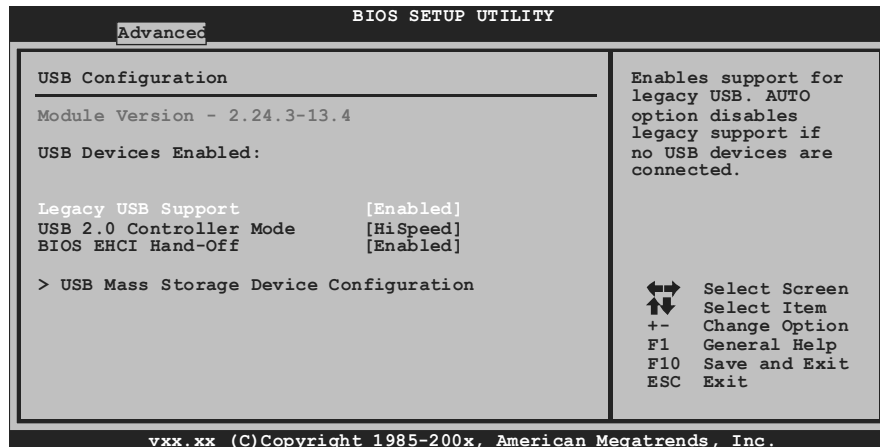

Legacy USB Support

This item determines if the BIOS should provide legacy support for USB devices like the keyboard, mouse, and USB drive. This feature is useful for using USB devices with operating systems that do not natively support USB (e.g. Microsoft MS-DOS or Windows NT).

Options: Enabled (Default) / Disabled / Auto

USB 2.0 Controller Mode

This item allows you to select the operation mode of the USB 2.0 controller.

Options: HiSpeed (Default) USB 2.0-480Mbps
 FullSpeed USB 1.1-12Mbps

BIOS EHCI Hand-Off

This item allows you to enable support for operating systems without an EHCI hand-off feature.

Options: Enabled (Default) / Disabled

USB Mass Storage Device Configuration

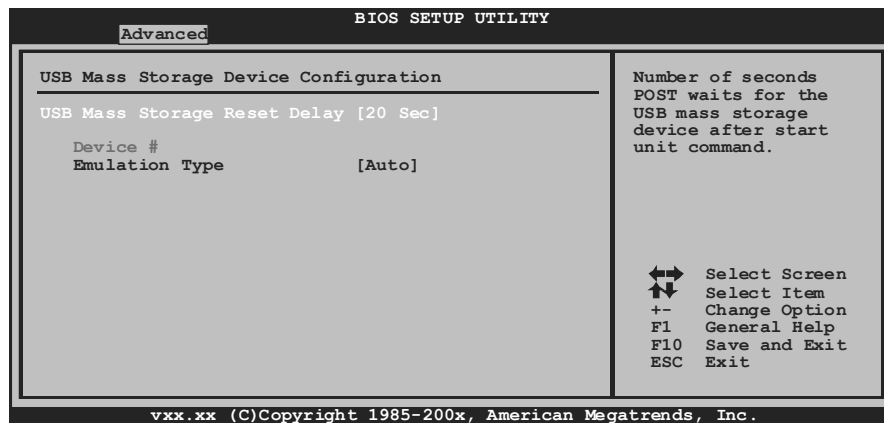

USB Mass Storage Reset Delay

This item allows you to set the reset delay for USB mass storage device.

Options: 20 Sec (Default) / 10 Sec / 30 Sec / 40 Sec

Emulation Type

This item allows you to select the emulation type of the USB mass storage device.

Options: Auto (Default) / Floppy / Forced FDD / Hard Disk / CDROM

3.3 PCI/PnP MENU

This section describes configuring the PCI bus system. PCI, or Personal Computer Interconnect, is a system which allows I/O devices to operate at speeds nearing the speed of the CPU itself uses when communicating with its own special components.

Notice

- Beware of that setting inappropriate values in items of this menu may cause system to malfunction.

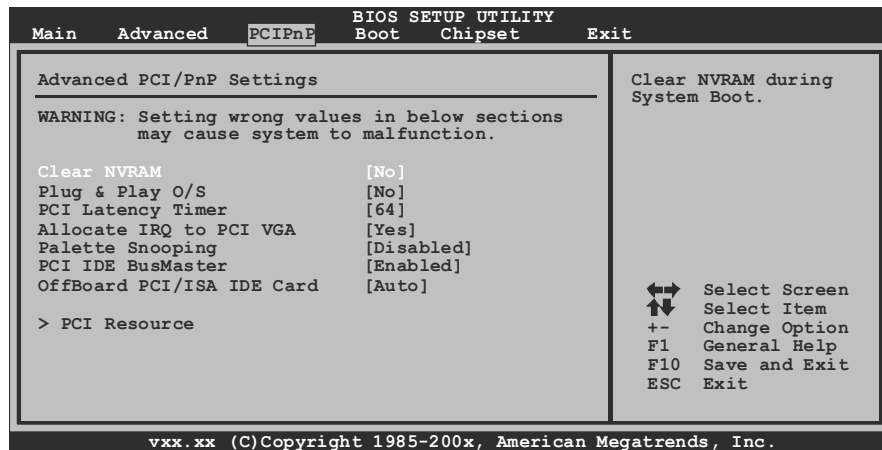

Clear NVRAM

This item allows you to clear the data in the NVRAM (CMOS) by selecting “Yes”.
Options: No (Default) / Yes

Plug & Play OS

When set to YES, BIOS will only initialize the PnP cards used for the boot sequence (VGA, IDE, SCSI). The rest of the cards will be initialized by the PnP operating system like Window™ 95. When set to NO, BIOS will initialize all the PnP cards. For non-PnP operating systems (DOS, Netware™), this option must set to NO.
Options: No (Default) / Yes

PCI Latency Timer

This item controls how long a PCI device can hold the PCI bus before another takes over. The longer the latency, the longer the PCI device can retain control of the bus before handing it over to another PCI device.

Options: 64 (Default) / 32 / 96 / 128 / 160 / 192 / 224 / 248

Allocate IRQ to PCI VGA

This item allows BIOS to choose a IRQ to assign for the PCI VGA card.

Options: Yes (Default) / No

Palette Snooping

Some old graphic controllers need to “snoop” on the VGA palette and then map it to their display as a way to provide boot information and VGA compatibility. This item allows such snooping to take place.

Options: Disabled (Default) / Enabled

PCI IDE BusMaster

This item is a toggle for the built-in driver that allows the onboard IDE controller to perform DMA (Direct Memory Access) transfers.

Options: Enabled (Default) / Disabled

OffBoard PCI/ISA IDE Card

This item is for any other non-onboard PCI/ISA IDE controller adapter.

Options: Auto (Default) / Disabled

PCI Resource

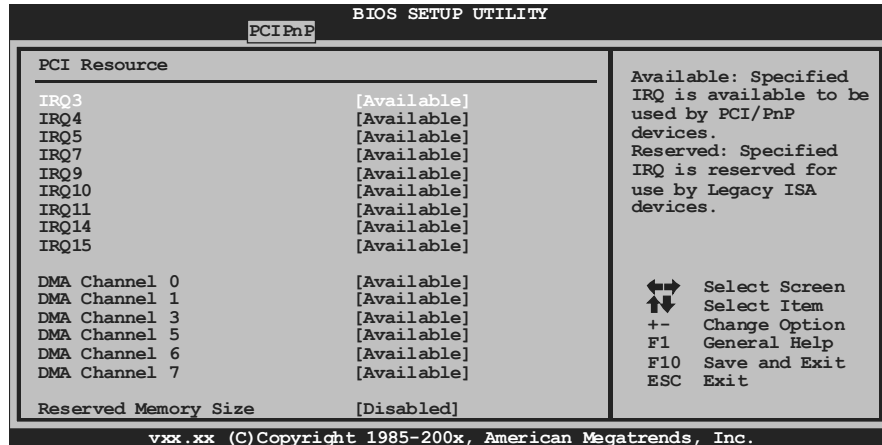

IRQ3/4/5/7/9/10/11/14/15

These items will allow you to assign each system interrupt a type, depending on the type of device using the interrupt. The option “Available” means the IRQ is going to assign automatically.

Options: Available (Default) / Reserved

DMA Channel 0/1/3/5/6/7

These items will allow you to assign each DMA channel a type, depending on the type of device using the channel. The option “Available” means the channel is going to assign automatically.

Options: Available (Default) / Reserved

Reserved Memory Size

This item allows BIOS to reserve certain memory size for specific PCI device.

Options: Disabled (Default) / 16K / 32K / 64K

3.4 BOOT MENU

This menu allows you to setup the system boot options.

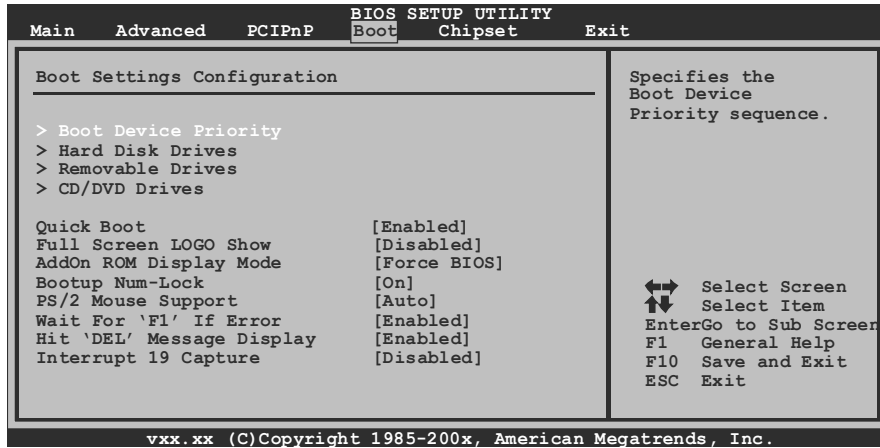

Boot Device Priority

Items in this sub-menu specify the boot device priority sequence from the available devices. The number of device items that appears on the screen depends on the number of devices installed in the system.

Hard Disk Drives

The BIOS will attempt to arrange the hard disk boot sequence automatically. You can also change the booting sequence. The number of device items that appears on the screen depends on the number of devices installed in the system.

Removable Drives

The BIOS will attempt to arrange the removable drive boot sequence automatically. You can also change the booting sequence. The number of device items that appears on the screen depends on the number of devices installed in the system.

CD/DVD Drives

The BIOS will attempt to arrange the CD/DVD drive boot sequence automatically. You can also change the booting sequence. The number of device items that appears on the screen depends on the number of devices installed in the system.

Quick Boot

Enabling this option will cause an abridged version of the Power On Self-Test (POST) to execute after you power up the computer.

Options: Enabled (Default) / Disabled

Full Screen LOGO Display

This item allows you to enable/disable Full Screen LOGO Show function.

Options: Disabled (Default) / Enabled

AddOn ROM Display Mode

This item sets the display mode for option ROM.

Options: Force BIOS (Default) / Keep Current

Bootup Num-Lock

Selects the NumLock State after the system switched on.

Options: On (Default) / Off

PS/2 Mouse Support

This BIOS feature determines if the BIOS should reserve IRQ12 for the PS/2 mouse or allow other devices to make use of this IRQ.

Options: Auto (Default) / Enabled

Wait for 'F1' If Error

This BIOS feature controls the system's response when an error is detected during the boot sequence.

Options: Enabled (Default) / Disabled

Hit 'DEL' Message Display

This BIOS feature allows you to control the display of the Hit "DEL" to enter Setup message during memory initialization.

Options: Enabled (Default) / Disabled

Interrupt 19 Capture

Interrupt 19 is the software interrupt that handles the boot disk function. When set to Enabled, this item allows the option ROMs to trap interrupt 19.

Options: Disabled (Default) / Enabled

3.5 CHIPSET MENU

This submenu allows you to configure the specific features of the chipset installed on your system. This chipset manage bus speeds and access to system memory resources, such as DRAM. It also coordinates communications with the PCI bus.

Notice

- Beware of that setting inappropriate values in items of this menu may cause system to malfunction.

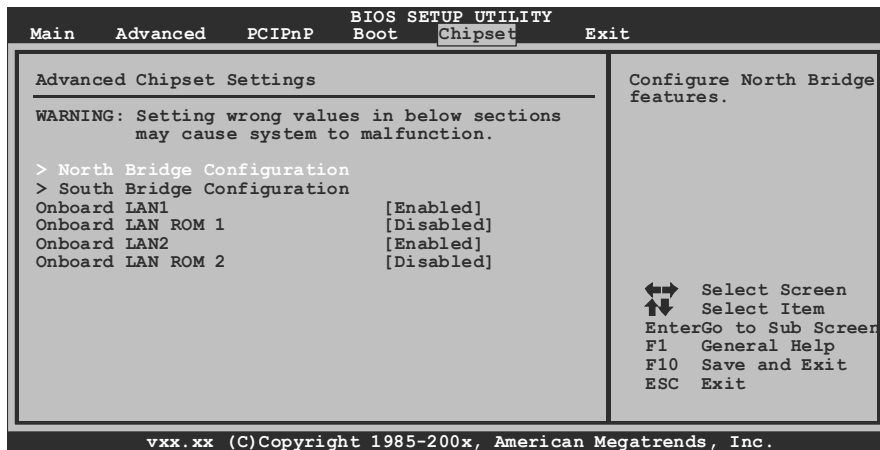

North Bridge Configuration

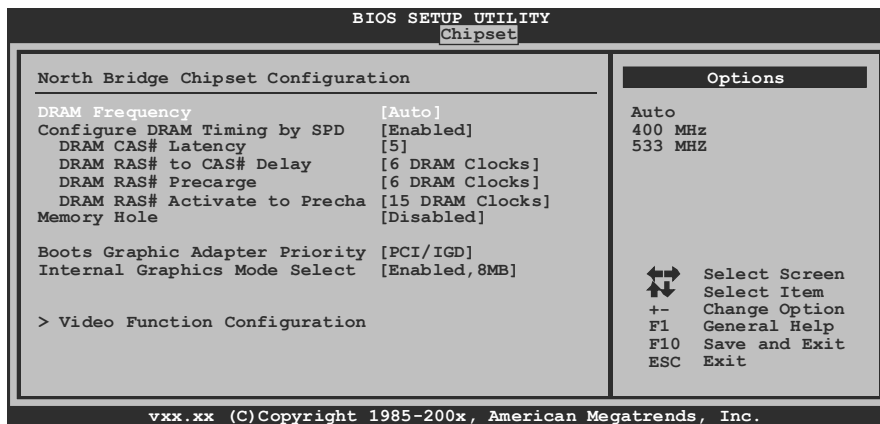

DRAM Frequency

This item allows you to set the frequency of DRAM.
Options: Auto (Default) / 400MHz / 533MHz

Configure DRAM timing by SPD

This item allows you to determine DRAM timing by SPD
Options: Enabled (Default) / Disabled

DRAM CAS# Latency

Options: 5 (Default) / 3 / 4

DRAM RAS# to CAS# Delay

Options: 6 DRAM Clocks (Default) / 2 ~ 7DRAM Clocks

DRAM RAS# Precharge

Options: 6 DRAM Clocks (Default) / 2 ~ 7DRAM Clocks

DRAM RAS# Activate to Precharge

Options: 15 DRAM Clocks (Default) / 4 ~ 14 DRAM Clocks

Memory Hole

You can reserve this area of system memory for ISA adapter ROM. When this area is reserved it cannot be cached. Check the user information of peripherals that need to use this area of system memory for the memory requirements.

Options: Disabled (Default) / 15MB-16MB

Boots Graphic Adapter Priority

Select which graphics controller to use as the primary boot device.

Options: PCI/IGD (Default) / IGD

Internal Graphics Mode Select

Select the amount of system memory used by the Internal graphics device. This item will be different as your memory modules. When the memory size is decided, this frame buffer size will also be fixed.

Options: Enabled, 8MB (Default) / Enabled, 1MB / Disabled

Video Function Configuration

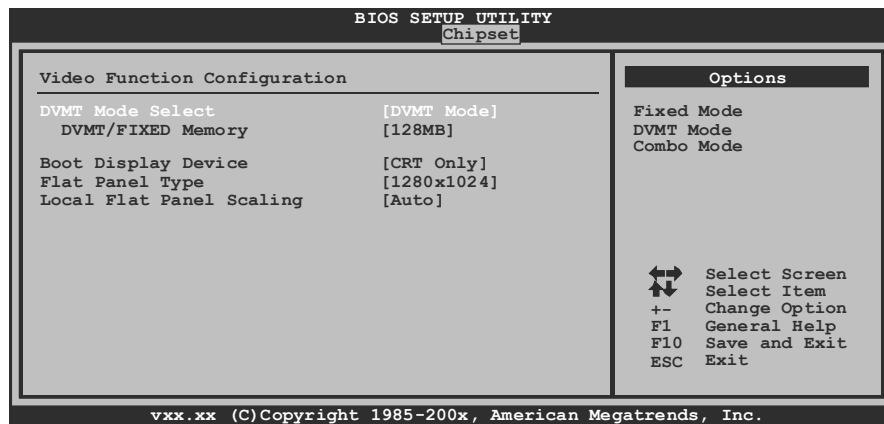

DVMT Mode Select

This item allows you to select the DVMT mode.

Options: DVMT Mode (Default) / Fixed Mode / Combo Mode

Mini-ITX Mainboard Manual

DVMT/FIXED Memory

DVMT stands for “Dynamic Video Memory Technology”. This is an enhancement of the unified memory architecture (UMA) concept. DVMT will set the optimum amount of memory to be allocated for a balance between graphics and system performance. DVMT dynamically respond to system requirements and applications demands, by allocating the proper amount of display, texturing and buffer memory after the operating system has booted.

Options: 128MB (Default) / 64MB / Maximum DVMT

Boot Display Device

This item allows you to select the display device.

Options: CRT Only (Default) / LVDS Only / CRT + LVDS

Flat Panel Type

This item allows you to select flat panel type.

Options: 1280x1024 2 (Default) / 1440x900 / 800x600 / 1024x768

Local Flat Panel Scaling

This item allows you to select local flat panel scaling

Options: Auto (Default) / Forced Scaling / Disabled

South Bridge Configuration

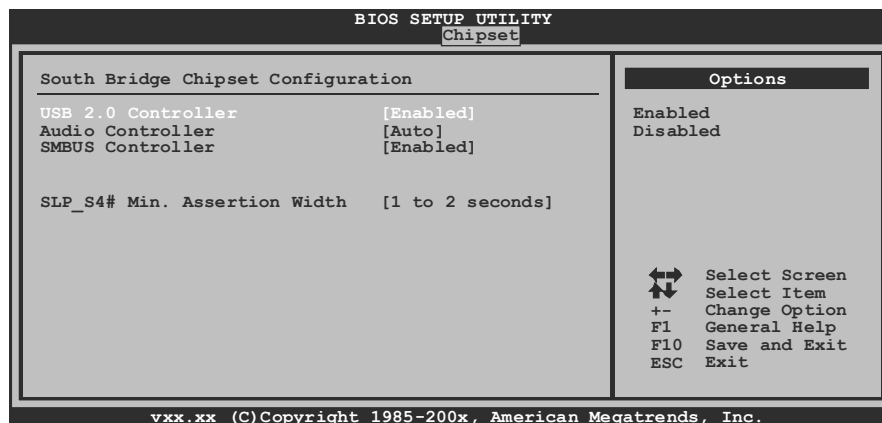

USB 2.0 Controller

This entry is to enabled/ disabled EHCI controller only. This BIOS itself may/may not have high speed USB support. If the BIOS has high speed USB support, the support will be automatically turned on when high speed devices were attached.

Options: Enabled (Default) / Disabled

Audio Controller

This item allows you to control the Audio support.

Options: Auto (Default) / Disabled

SMBUS Controller

This BIOS feature controls the I/O buffers for the SMBus.

Options: Enabled (Default) / Disabled

SLP_S4# Min. Assertion Width

Options: 1 to 2 seconds (Default) / 4 to 5 seconds / 3 to 4 seconds / 2 to 3 seconds

Onboard LAN 1/2

This item allows you to enable or disable the Onboard LAN 1/2.

Options: Enabled (Default) / Disabled

Onboard LAN ROM 1/2

This item allows you to select the Onboard LAN 1/2 Boot ROM.

Options: Disabled (Default) / Enabled

3.6 EXIT MENU

This menu allows you to load the optimal default settings, and save or discard the changes to the BIOS items.

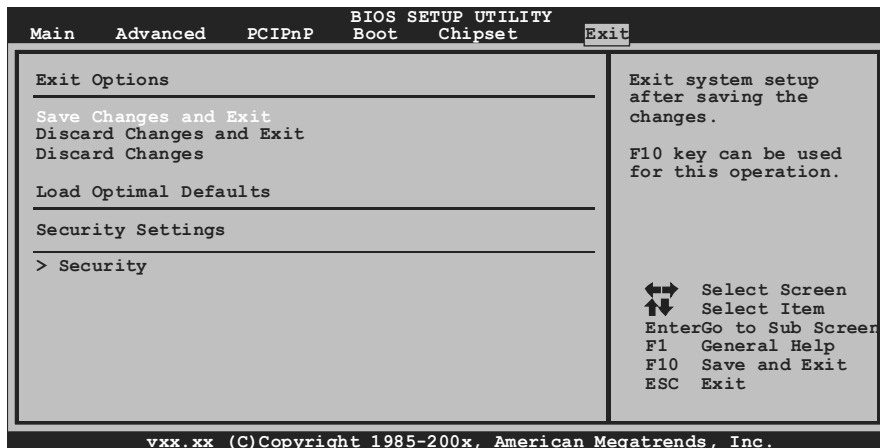

Save Changes and Exit

Save all configuration changes to CMOS RAM and exit setup.

Discard Changes and Exit

Abandon all changes made during the current session and exit setup.

Discard Changes

Abandon all changes made during the current session and restore the previously saved values.

Load Optimal Defaults

This selection allows you to reload the BIOS when problem occurs during system booting sequence. These configurations are factory settings optimized for this system.

Security

This sub-menu allows you to provide/revise supervisor and user password.

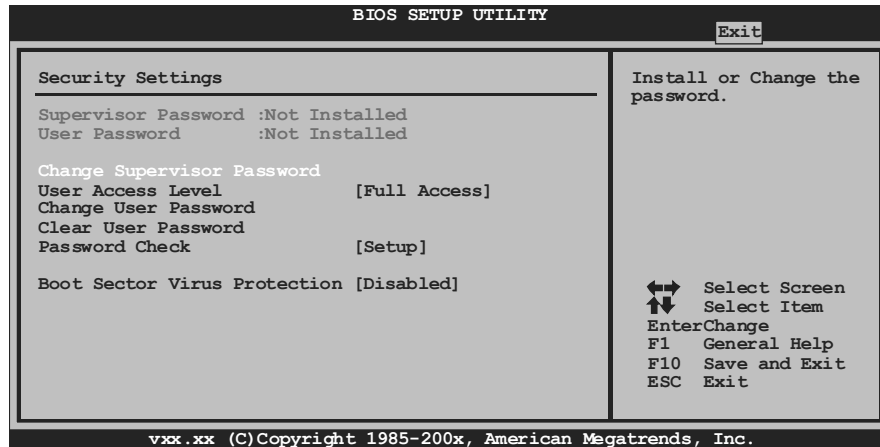

Change Supervisor Password

Setting the supervisor password will prohibit everyone except the supervisor from making changes using the CMOS Setup Utility. You will be prompted with to enter a password.

User Access Level

This item allows supervisor to set the user level.
Options: Full Access (Default) / No Access / View Only / Limited

Change User Password

If the Supervisor Password is not set, then the User Password will function in the same way as the Supervisor Password. If the Supervisor Password is set and the User Password is set, the "User" will only be able to view configurations but will not be able to change them.

Clear User Password

This item is for clearing user password.

Password Check

This item is for setting the timing that checking password.

Options: Setup (Default) / Always

Boot Sector Virus Protection

This option allows you to choose the VIRUS Warning feature that is used to protect the IDE Hard Disk boot sector. If this function is enabled and an attempt is made to write to the boot sector, BIOS will display a warning message on the screen and sound an alarm beep.

Options: Disabled (Default) / Enabled

CHAPTER 4: USEFUL HELP

4.1 DRIVER INSTALLATION NOTE

After you installed your operating system, please insert the Fully Setup Driver CD into your optical drive and install the driver for better system performance.

You will see the following window after you insert the CD



The setup guide will auto detect your mainboard and operating system.

Note:

If this window didn't show up after you insert the Driver CD, please use file browser to locate and execute the file **SETUP.EXE** under your optical drive.

A. Driver Installation

To install the driver, please click on the Driver icon. The setup guide will list the compatible driver for your mainboard and operating system. Click on each device driver to launch the installation program.

B. Software Installation

To install the software, please click on the Software icon. The setup guide will list the software available for your system, click on each software title to launch the installation program.

C. Manual

Aside from the paperback manual, we also provide manual in the Driver CD. Click on the Manual icon to browse for available manual.

Note:

You will need Acrobat Reader to open the manual file. Please download the latest version of Acrobat Reader software from <http://www.adobe.com/products/acrobat/readstep2.html>

4.2 AMI BIOS BEEP CODE

Boot Block Beep Codes

Number of Beeps	Description
1	No media present. (Insert diskette in floppy drive A:)
2	"AMIBOOT.ROM" file not found in root directory of diskette in A:
3	Insert next diskette if multiple diskettes are used for recovery
4	Flash Programming successful
5	File read error
7	No Flash EPROM detected
10	Flash Erase error
11	Flash Program error
12	"AMIBOOT.ROM" file size error
13	BIOS ROM image mismatch (file layout does not match image present in flash device)

POST BIOS Beep Codes

Number of Beeps	Description
1	Memory refresh timer error
3	Base memory read/write test error
6	Keyboard controller BAT command failed
7	General exception error (processor exception interrupt error)
8	Display memory error (system video adapter)

Troubleshooting POST BIOS Beep Codes

Number of Beeps	Troubleshooting Action
1, 3	Reseat the memory, or replace with known good modules.
6, 7	<p>Fatal error indicating a serious problem with the system. Consult your system manufacturer. Before declaring the motherboard beyond all hope, eliminate the possibility of interference by a malfunctioning add-in card. Remove all expansion cards except the video adapter.</p> <ul style="list-style-type: none"> ● If beep codes are generated when all other expansion cards are absent, consult your system manufacturer's technical support. ● If beep codes are not generated when all other expansion cards are absent, one of the add-in cards is causing the malfunction. Insert the cards back into the system one at a time until the problem happens again. This will reveal the malfunctioning card.
8	If the system video adapter is an add-in card, replace or reseat the video adapter. If the video adapter is an integrated part of the system board, the board may be faulty.

4.3 TROUBLESHOOTING

Probable	Solution
<ol style="list-style-type: none"> 1. There is no power in the system. Power LED does not shine; the fan of the power supply does not work 2. Indicator light on keyboard does not shine. 	<ol style="list-style-type: none"> 1. Make sure power cable is securely plugged in. 2. Replace cable. 3. Contact technical support.
System is inoperative. Keyboard lights are on, power indicator lights are lit, and hard drives are running.	Using even pressure on both ends of the DIMM, press down firmly until the module snaps into place.
System does not boot from a hard disk drive, but can be booted from optical drive.	<ol style="list-style-type: none"> 1. Check cable running from disk to disk controller board. Make sure both ends are securely plugged in; check the drive type in the standard CMOS setup. 2. Backing up the hard drive is extremely important. All hard disks are capable of breaking down at any time.
System only boots from an optical drive. Hard disks can be read, applications can be used, but system fails to boot from a hard disk.	<ol style="list-style-type: none"> 1. Back up data and applications files. 2. Reformat the hard drive. Re-install applications and data using backup disks.
Screen message shows "Invalid Configuration" or "CMOS Failure."	Review system's equipment. Make sure correct information is in setup.
System cannot boot after user installs a second hard drive.	<ol style="list-style-type: none"> 1. Set master/slave jumpers correctly. 2. Run SETUP program and select correct drive types. Call the drive manufacturers for compatibility with other drives.

2010/11/12